

PRACTICAL & EASY TO INSTALL SOLUTIONS



LOW VOLTAGE CONSUMER UNITS & DISTRIBUTION BOARDS UP TO 250 A

→ CATALOGUE PAGES INSIDE

THE **GLOBAL SPECIALIST**
IN ELECTRICAL AND DIGITAL BUILDING INFRASTRUCTURES

 **legrand**[®]



The Legrand ranges of British standard consumer units and Convivio™ distribution boards are especially designed in order to provide quick & easy installation, safety and reliability in the electrical installation of residential or small commercial buildings. Both of them allow to achieve assemblies conform to IEC 61439.

BRITISH STANDARD CONSUMER UNITS

PRACTICAL AND FUNCTIONAL 1P+N AND 3P+N
BRITISH STANDARD METAL CONSUMER UNITS.



P3

CONVIVIO™ DISTRIBUTION BOARDS

COMPLETE READY TO USE 3-PHASE DISTRIBUTION
BOARDS UP TO 250 A.



P6



legrand

British standard consumer units

Designed
to be practical
and functional

The IP41 British standard metal consumer units are designed to meet the needs of residential and small commercial buildings installations. They can be also used in hotels to equip rooms for example.

Available in 2 versions Single-phase + neutral and 3-phase + neutral, to ensure optimised distribution on different types of sites.

9 SIZES OF CONSUMER UNITS

Single-phase + neutral:
from 4 to 16 ways
3-phase + neutral:
from 4 to 12 ways.

1 CATALOGUE NUMBER = 1 COMPLETE CONSUMER UNIT

The same cabinet can be flush or surface mounted (easier choice and only few catalogue numbers to store).



Single-phase + neutral.



3-phase + neutral.

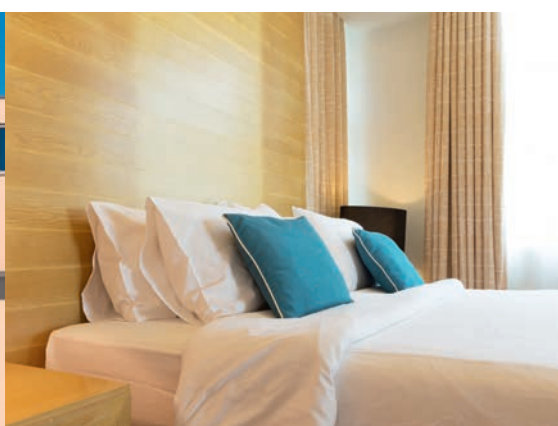

DESIGNED FOR THE RESIDENTIAL SECTOR OR SMALL COMMERCIAL BUILDINGS

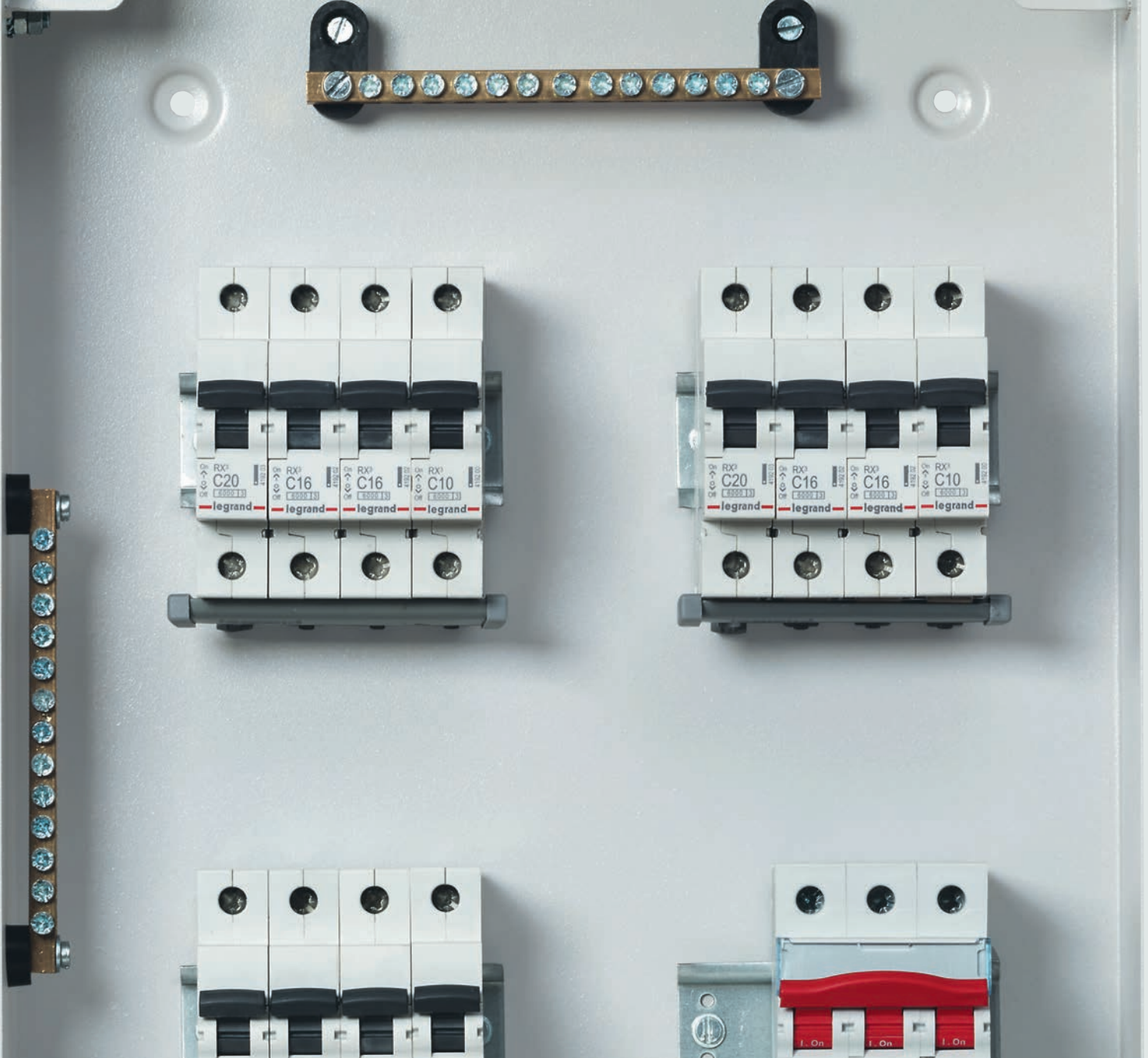

Flush or surface mounting

Multiple benefits allowing simplified installation and electrical distribution

Removable cable entry plate, precut cable entries, fork-type supply busbars, ergonomic handle or box finishing ...

the benefits of the British standard consumer units are numerous. They have been designed to simplify the installer's work and to save time during installation and wiring.

Neutral and Earth terminal blocks.

DIN rail for modular equipment.

Fork-type supply busbar for easier wiring operations (supplied with the consumer units).

Flush or surface mounting according to required configuration. No additional accessories needed.

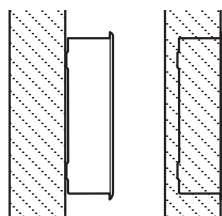
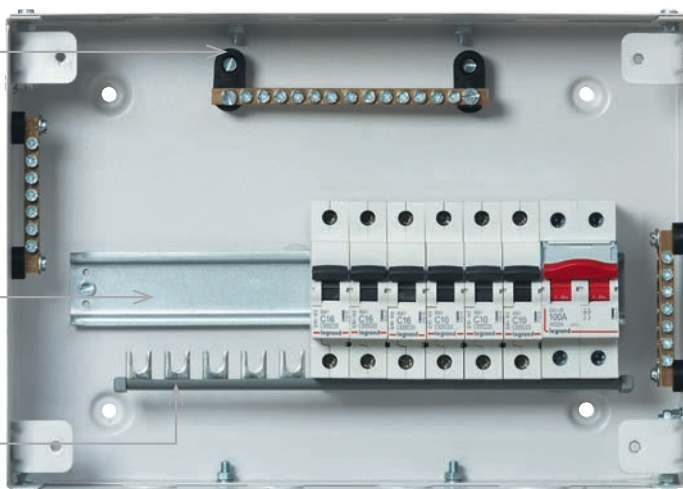

Specific labels on each side of the cabinets for easy identification of the earth terminals.



The box is painted in the same colour like the door and the faceplate, ensuring a perfect finish when the cabinets are surface mounted.

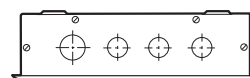

Significant time saving thanks to the pre-cut cable entries at the top and at the bottom of the cabinets. Diameter: max. 32 mm.

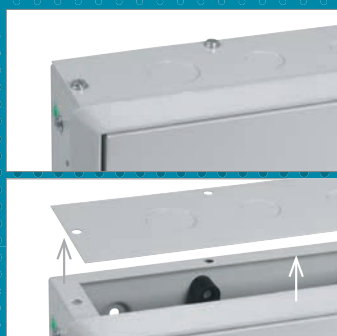

Easily removable cable entry plates at the top and at the bottom of the cabinets, allowing the installation of large dimensions ducts.

Integrated earthing system, fixed directly on the door for immediate accessibility.

Ergonomic handle. A simple finger push opens the door easily. Made of plastic for good resistance to corrosion.

Face plate without cutting edges for maximum protection of the users when the cabinet is surface mounted.

legrand



Convivio™, distribution boards

**Complete
ready to use
distribution
boards**

Specially designed for the residential sector or small commercial buildings, the new range Convivio™ distribution boards can be installed in individual houses, villas or blocks of flats. With their sophisticated design and neutral colour they blend in discreetly in all types of contemporary interiors.

8 SIZES OF BOARD

from 4 to 18 three-pole ways.

1 CATALOGUE NUMBER = 1 COMPLETE, READY TO USE BOARD

Only a few catalogue numbers to store (the same board can be flush-mounted or surface-mounted).



DESIGNED FOR THE RESIDENTIAL SECTOR OR SMALL COMMERCIAL BUILDINGS...

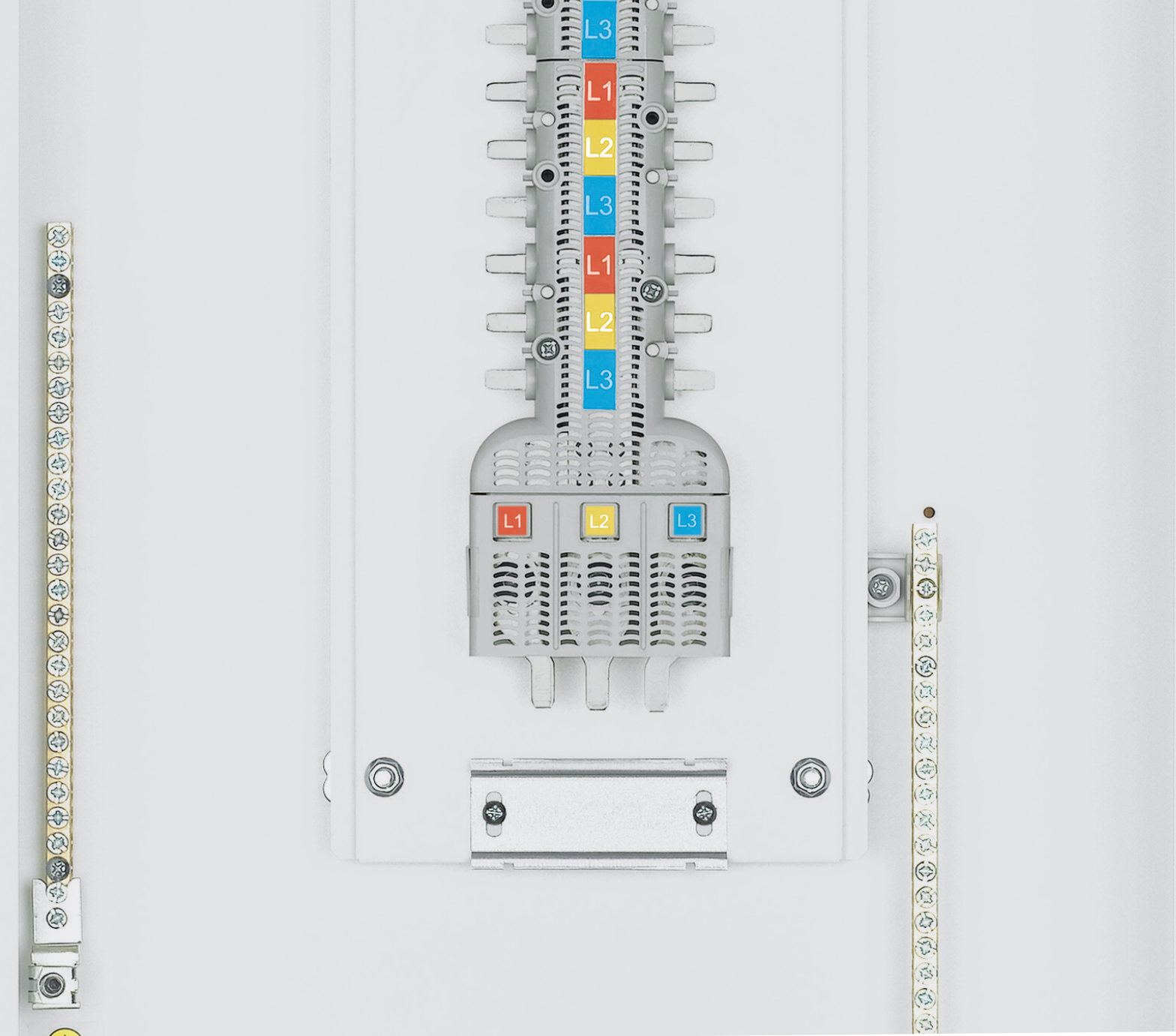

An optimised range

Simple choice
according to the type
and rating of the circuit
breaker and number
of outgoing terminals

Available in 3 versions according to the main circuit breaker, the new range represents a very competitive advantage on residential sites, with the number of catalogue numbers halved. The boards are ready to use, with pre-fitted doors, faceplate, distribution system, connection terminals, neutral and earth terminal blocks and fixing device for the main circuit breaker.

UP TO 125 A

MODULAR CIRCUIT BREAKER
1 MODULE/POLE UP TO 125 A.

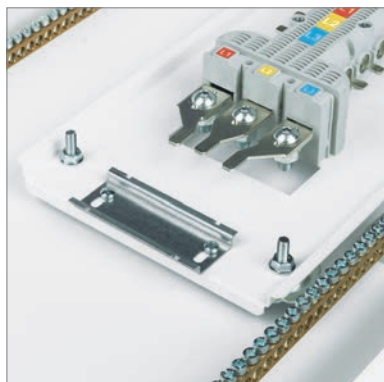

Board equipped with DIN rail,
ready to take the modular
circuit breaker.

UP TO 250 A

DRX 125 OR DRX 250 MCCB ACCORDING TO THE BOARD VERSION CHOSEN.

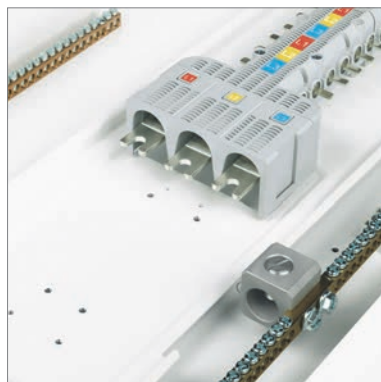

Board supplied with plate,
terminals and terminal shield.

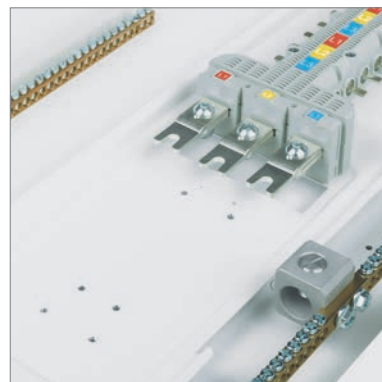

Board ready to take the MCCB.

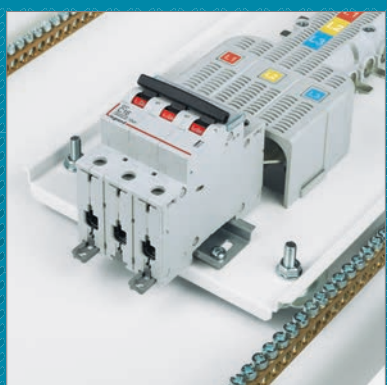

Fitting the circuit breaker and
terminal shield.

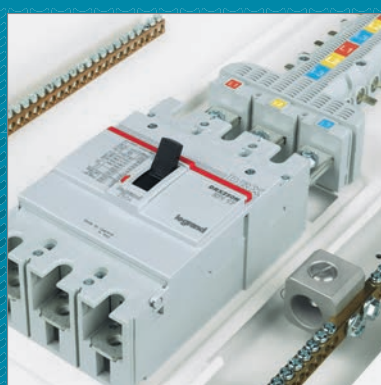

Fixing the circuit breaker on a plate.

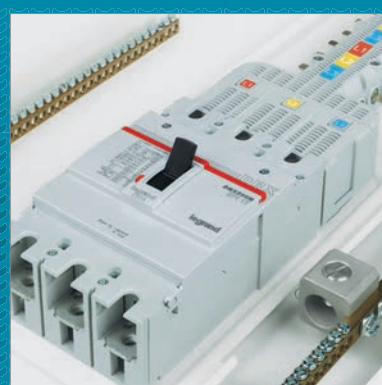

Fitting the terminal shield.

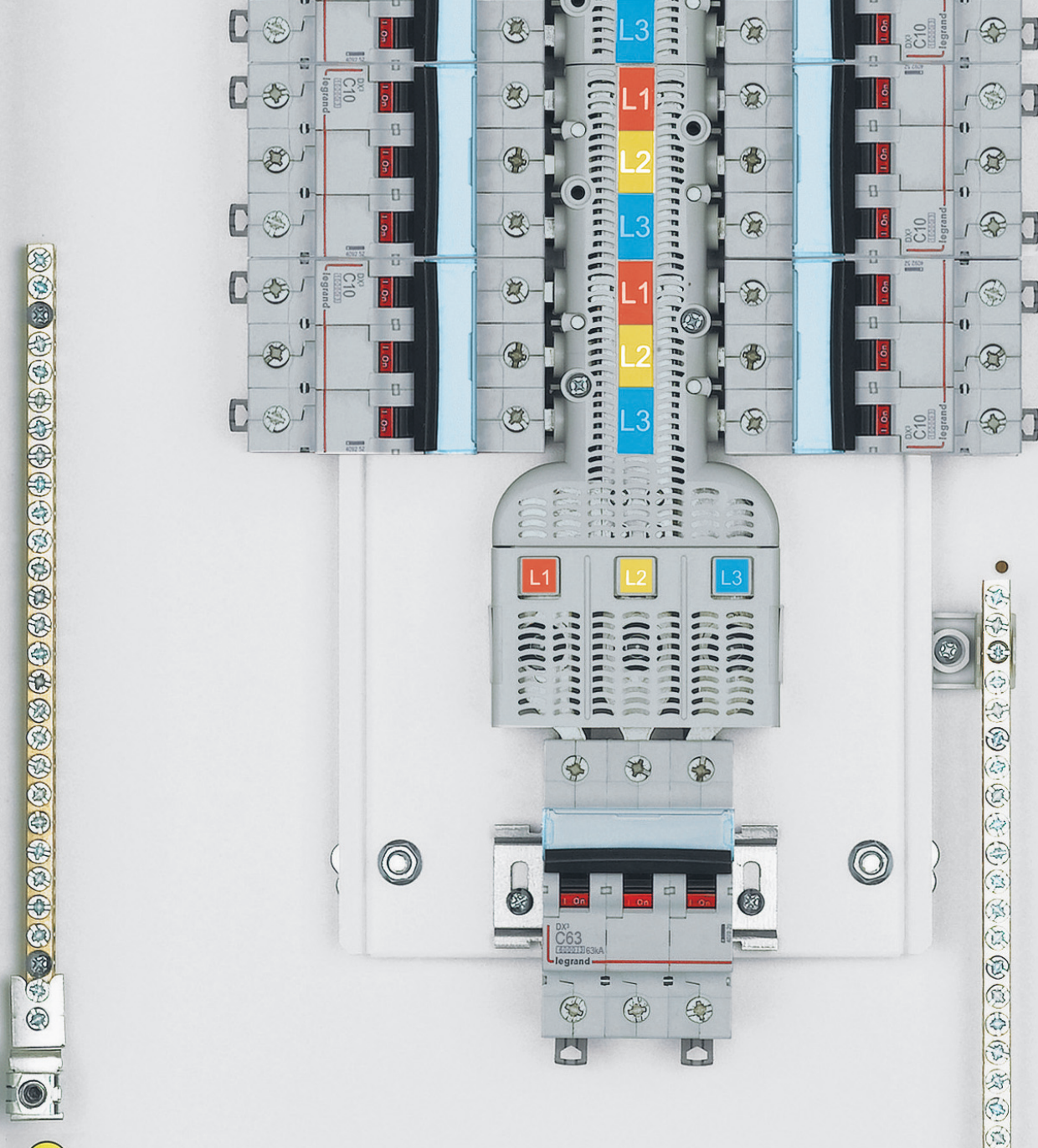

Easy installation and wiring

From the board to the
circuit breaker,
everything is done
to simplify installation

Convivio™ distribution boards have been designed to save time and make installation as easy as possible, making it ideal for the residential market, which is particularly competitive.

Special shape fixing holes allowing position adjustments during installation.

Fully isolated (tin plated copper) busbar.

Earth terminal.

Terminal shields for main circuit breaker.

DIN rail for main MCB.

Neutral terminal.

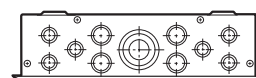
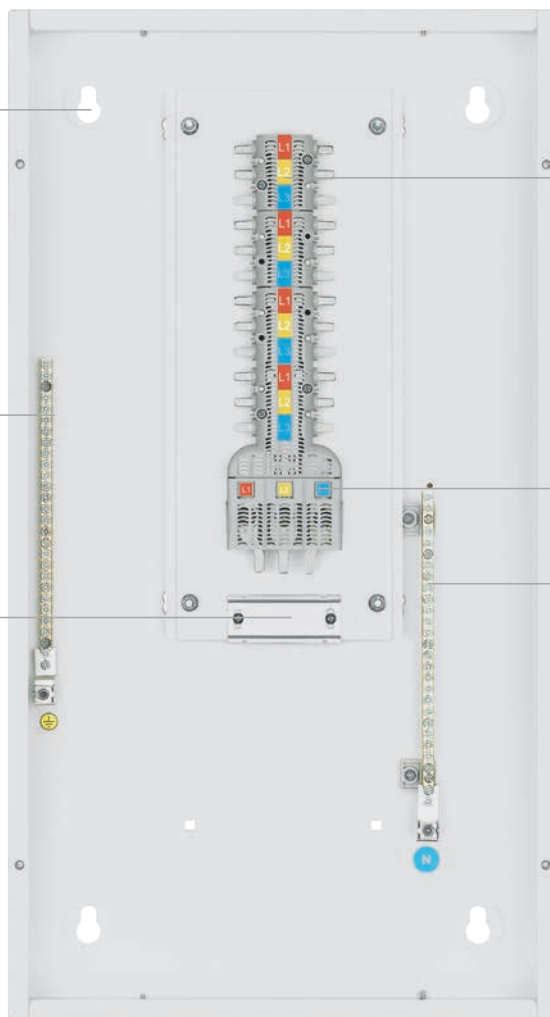

Pre-cut cable entries at the top and at the bottom of the board.



Height adjustment under the circuit breaker fixing plate.

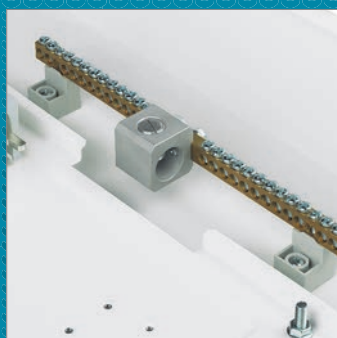

Neutral terminal block with high-capacity terminal.



Earth terminal block. Same number of connections as the number of outgoing terminals on the board.

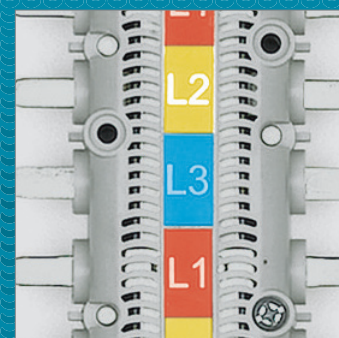

Coloured labels to identify each phase on the busbar and on the faceplate.

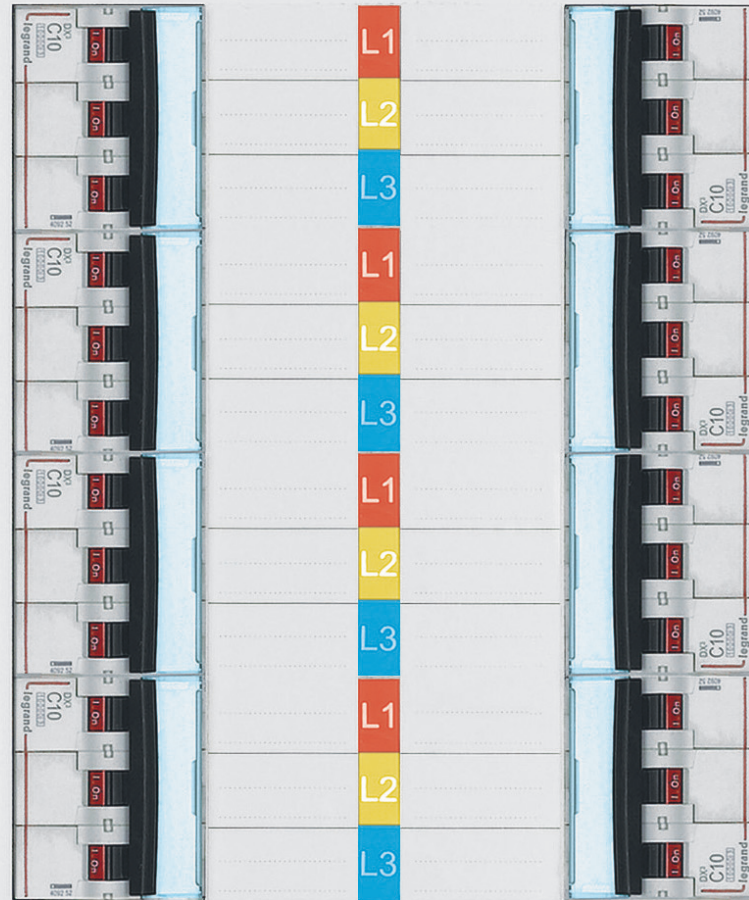

High quality and strength

Choosing a Convivio™
distribution board
means choosing
Legrand quality

Legrand has always been committed to complying with standards to ensure optimum safety on sites, and ensures its products all incorporate the high quality, strength, reliability and immaculate finish for which the brand is renowned.

**TYPE
TESTED
BUSBAR**
IEC 61439-2
STANDARD

TOTALLY RELIABLE, THEY
ARE TESTED AND APPROVED
FOR THEIR COMPLIANCE
WITH IEC 61439-2 STANDARD

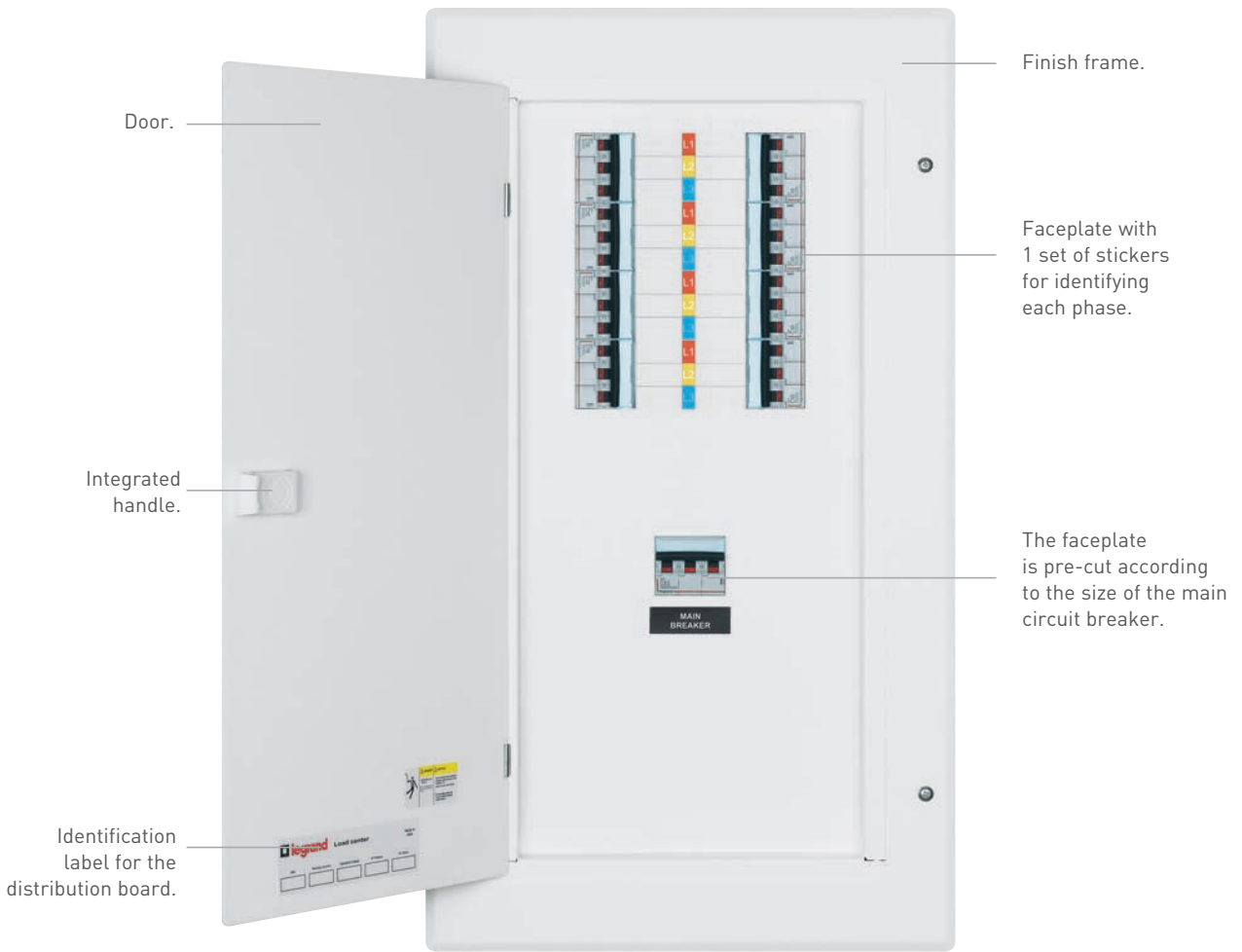

Door.

Finish frame.

Integrated handle.

Faceplate with 1 set of stickers for identifying each phase.

Identification label for the distribution board.

The faceplate is pre-cut according to the size of the main circuit breaker.

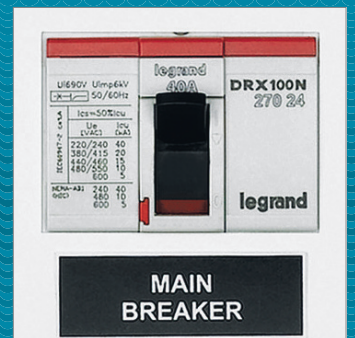

Terminal shield for the main circuit breaker (supplied with the board).

Terminal shield on outlets that are not in use.

Distribution board identification label.

Main circuit breaker identification label.

Flush-mounting British standard consumer units



4 025 08



4 025 15

Allows to achieve assemblies conform to IEC 61439-3

Pack	Cat.Nos	Single phase + neutral consumer units			
		Metal IP 41 Grey Supplied with earth and neutral terminal blocks and 100 A isolated fork type supply busbar Door earthing			
		Number of ways	Number of modules	Number of supply busbars	Number of modules per busbar
1	4 025 05	4	2 + 4	1	4
1	4 025 06	6	2 + 6	1	6
1	4 025 07	8	2 + 8	1	8
1	4 025 08	12	2 + 12	1	12
1	4 025 09	16	2 + 14	1	16

Pack	Cat.Nos	Three-phase + neutral consumer units			
		Metal IP 41 Grey Supplied with earth and neutral terminal blocks and 100 A isolated fork type supply busbar Door earthing			
		Three-phase distribution board for single phase outgoing			
		Number of ways	Number of modules	Number of supply busbars	Number of modules per busbar
1	4 025 15	4	4 + 12	3	4
1	4 025 16	6	4 + 18	3	6
1	4 025 17	8	4 + 24	3	8
1	4 025 18	12	4 + 36	3	12

Flush-mounting British standard consumer units

technical characteristics

Presentation



Single phase + neutral

3-phase + neutral

Dimensions

Flush-mounting Single Phase + Neutral

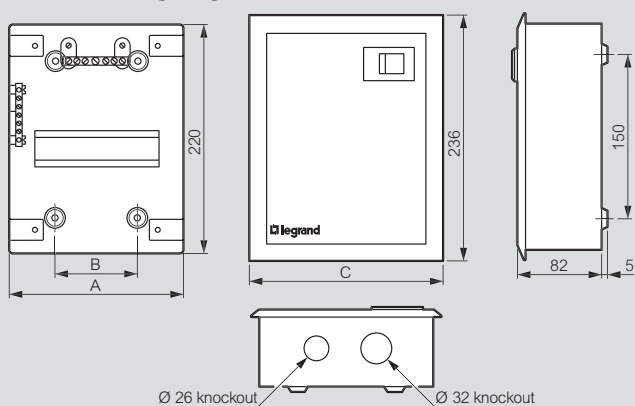

Cat.Nos	No. of ways	Dimensions (mm)			Top Ø25 knockout	Bottom Ø32 knockout
		A	B	C		
4 025 05	4	170	80	190	1 no.	1 no.
4 025 06	6	210	120	230	1 no.	1 no.
4 025 07	8	240	150	260	2 nos.	1 no.
4 025 08	12	316	226	336	3 nos.	1 no.
4 025 09	16	388	298	408	4 nos.	1 no.

Flush-mounting Three-phase + Neutral

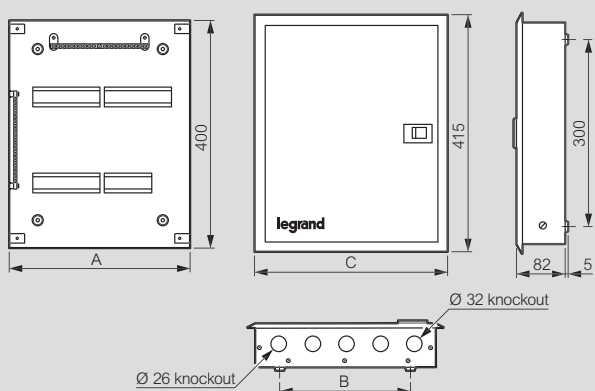

Cat.Nos	No. of ways	Dimensions (mm)			Top Ø25 knockout	Bottom Ø32 knockout
		A	B	C		
4 025 15	4	285	195	305	3 nos.	1 no.
4 025 16	6	321	231	341	4 nos.	1 no.
4 025 17	8	405	315	425	5 nos.	1 no.
4 025 18	12	549	459	569	7 nos.	1 no.

Convivio™ 3-phase distribution boards

from 12 to 54 poles



Technical characteristics p. 17

3-phase distribution boards for DIN-rail mounting circuit breakers

IP 40 - IK 08 with door

Conform to standard IEC 61439-3: busbar type tested (Lovag certified)

Maximum voltage 480 V \sim ; Rated short-time withstand current (Icw): 17 kA 0.2 s

Rated peak withstand current (Ipk): 34 kA

Ambient temperature: 50 °C continuously

White RAL 9003

Supplied with: surface or flush-mounting box, door with handle, faceplate, fully isolated tin plated copper busbar

The number of holes of earth and neutral terminal blocks are equal to the number of outgoing devices

Pack	Cat.Nos	Distribution boards up to 125 A	
		Maximum rating 125 A	
		Flush or surface mounting	
		Equipped with rail for main circuit breaker :	
		3P or 3P + N (Neutral on the right-hand side),	
		1 module/pole, rail mounting MCB	
		No of poles (outgoing terminals)	No of 3P ways
1	6 044 00	12	4
1	6 044 01	18	6
1	6 044 02	24	8
1	6 044 03	30	10
1	6 044 04	36	12
1	6 044 05	42	14
1	6 044 06	48	16
1	6 044 07	54	18

Pack	Cat.Nos	Accessories
10	6 054 93	Fixing supports for terminal blocks Kit consisting of 2 insulated fixing supports for terminal blocks for earth
10	6 054 94	Insulating caps Set of 20 insulating caps for protecting unused outgoing terminals of the busbar
10	0 016 65	Blanking plate RAL 7035 Separable into modules or 1/2 modules 18 modules

Pack	Cat.Nos	Distribution boards up to 250 A	
		Maximum rating 125 A	
		Flush or surface mounting	
		Equipped with mounting plate for main circuit breaker: DRX 125 MCCB	
		No of poles (outgoing terminals)	No of 3P ways
1	6 044 30	12	4
1	6 044 31	18	6
1	6 044 32	24	8
1	6 044 33	30	10
1	6 044 34	36	12
1	6 044 35	42	14
1	6 044 36	48	16
1	6 044 37	54	18
		Maximum rating 250 A	
		Flush or surface mounting	
		Equipped with mounting plate for main circuit breaker: DRX 250 MCCB	
		No of poles (outgoing terminals)	No of 3P ways
1	6 044 40	18	6
1	6 044 41	24	8
1	6 044 42	30	10
1	6 044 43	36	12
1	6 044 44	42	14
1	6 044 45	48	16
1	6 044 46	54	18

Convivio™ 3-phase distribution boards

from 12 to 54 poles

■ Dimensions

Distribution boards from 12 to 24 poles (outgoing terminals)

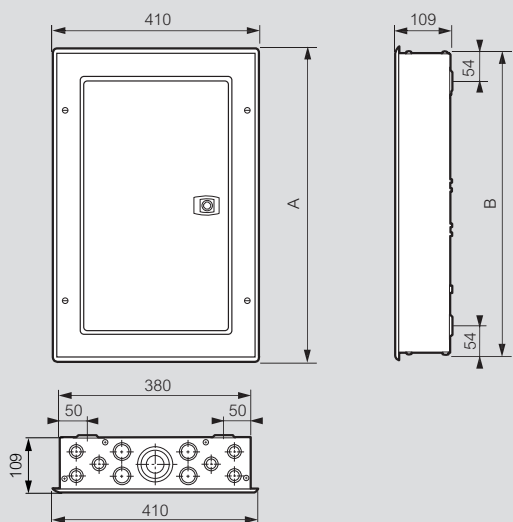

Cat.Nos	Number of poles	Dimensions (mm)	
		A	B
6 044 00	12	622	594
6 044 01	18	676	648
6 044 02	24	730	702
6 044 30	12	622	594
6 044 31	18	676	648
6 044 32	24	730	702
6 044 40	18	622	594
6 044 41	24	676	648

Number of knockouts	Size of the knockouts		
	∅18 / ∅27 mm	∅27 / ∅32 mm	∅32 / ∅52 / ∅65 mm
Top	2	2	1
Bottom	2	2	1

Distribution boards from 30 to 54 poles (outgoing terminals)

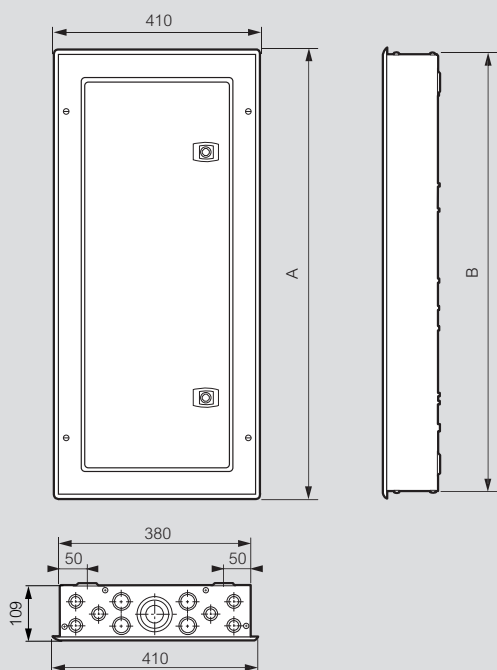



Cat.Nos	Number of poles	Dimensions (mm)	
		A	B
6 044 03	30	784	756
6 044 04	36	838	810
6 044 05	42	892	864
6 044 06	48	946	918
6 044 07	54	1000	972
6 044 33	30	784	756
6 044 34	36	838	810
6 044 35	42	892	864
6 044 36	48	946	918
6 044 37	54	1000	972
6 044 42	30	784	756
6 044 43	36	838	810
6 044 44	42	892	864
6 044 45	48	946	918
6 044 46	54	1000	972

Number of knockouts	Size of the knockouts		
	∅18 / ∅27 mm	∅27 / ∅32 mm	∅32 / ∅52 / ∅65 mm
Top	2	2	1
Bottom	2	2	1



EXB 16038 - November 2016

FOLLOW US ALSO ON

- @ www.legrand.com
-  youtube.com/user/legrand
-  twitter.com/legrand_news
-  pinterest.com/legrandgroup



World Headquarters
and International Department
87045 Limoges Cedex - France
☎ : + 33 (0) 5 55 06 87 87
Fax: + 33 (0) 5 55 06 74 55